

Lucerna U-ARM Series

U_Arm Dynamic X ray



Lucerna-UARM



The new X-RAY generation
Digital Radiography Solution

Lucerna-UArm

State-of-the-art dynamic FPD Technology for R&F

LUCERNA U-Arm can extend SID to 180cm, allowing to obtain chest images comparable to those done on a chest stand, making the device suitable also for routine exams.

Wide movement range of both U-CARM and detector can satisfy exposure demands of the entire body position.

With advanced image processing workstation, dynamic DR System can provide high definition full-body image with the range from head to toe, especially helpful for orthopedics.

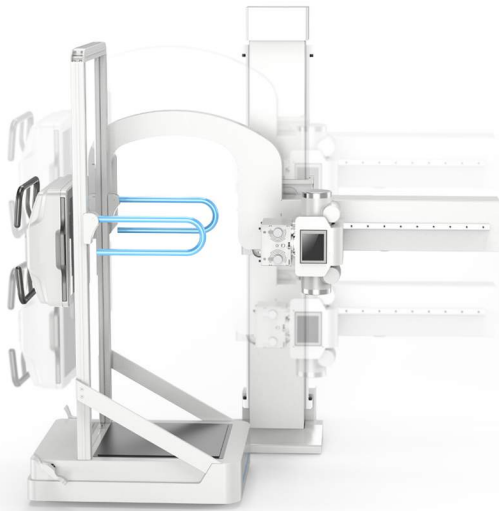

Stitching

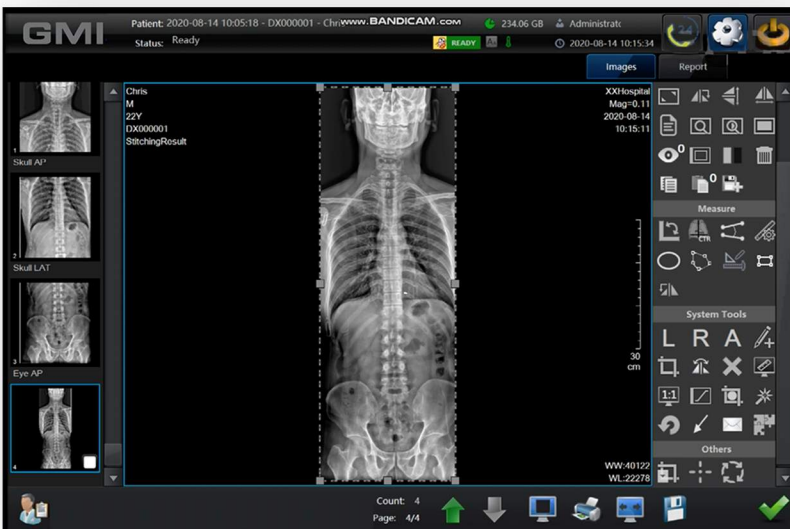

High-performance System Satisfy User Experience

Smart Image stitching with advanced image processing workstation, dynamic DR -System can provide high definition full body image with the range from head to toe, especially helpful for orthopedics.

Real-time entire contrast observation, one image shows all the details.

Lucerna-UARM

**Lucerna U ARM
(WD 3D)**



The new X-RAY generation
Digital Radiography Solution

Lucerna-UArm WD 3D

State-of-the-art dynamic FPD Technology for R&F

The **Lucerna U_Arm WD 3D** exams deliver a highly accurate view of the musculoskeletal system through full body, weight-bearing 3D images.

Our system calculates precise 2D and 3D measurements without magnification or stitching bias.

High-accuracy imaging data from WD 3D allows providers to plan treatment strategies around each patient's unique 3D anatomy. WD 3D exams are unique because they capture the front and side view of your body at the same time.

Unlike traditional X-ray imaging, where the patient may have to be repositioned to get views from different angles, these two simultaneous scans provide all the imaging necessary.



● Whole Body 3D

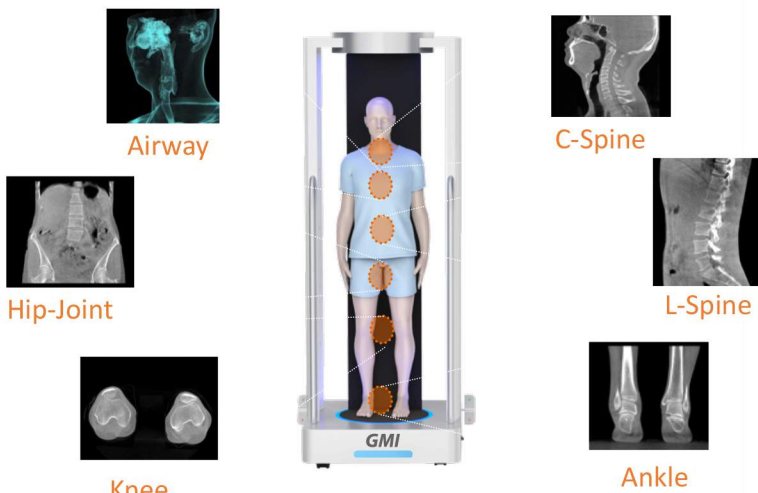

High-performance System Satisfy User Experience

The images from your patient's WD 3D imaging exam are available immediately.

Because WD 3D creates 3-D images, there is no need to piece together multiple images.

The child won't need a protective lead apron like in a traditional x-ray because of the extremely low radiation dose from WD 3D.

**Lucerna U ARM
(WD 3D)**

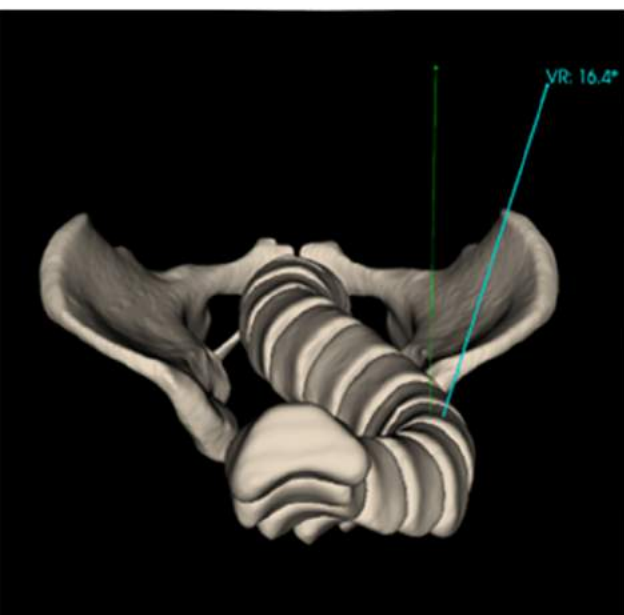
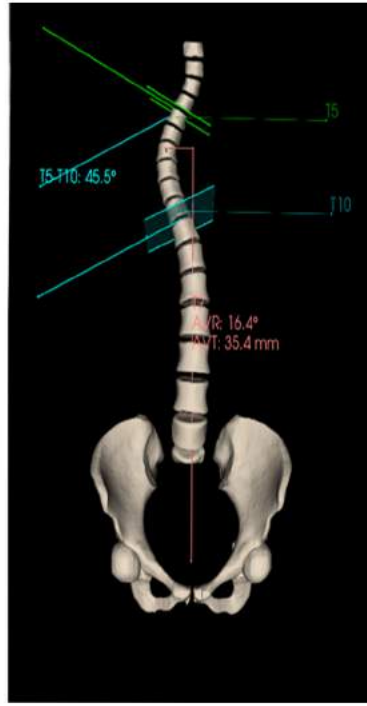
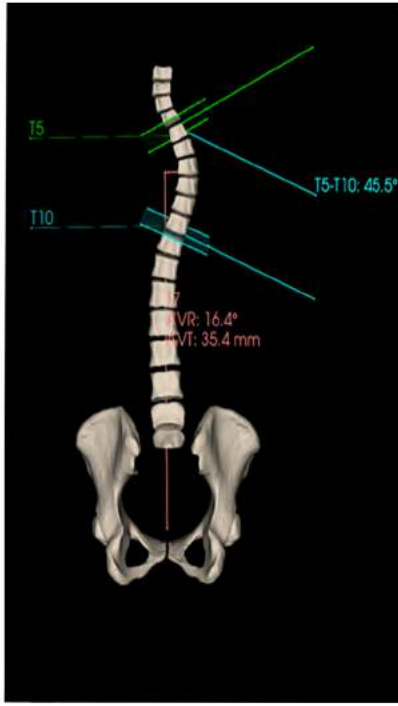

Excellent
image
quality 3D



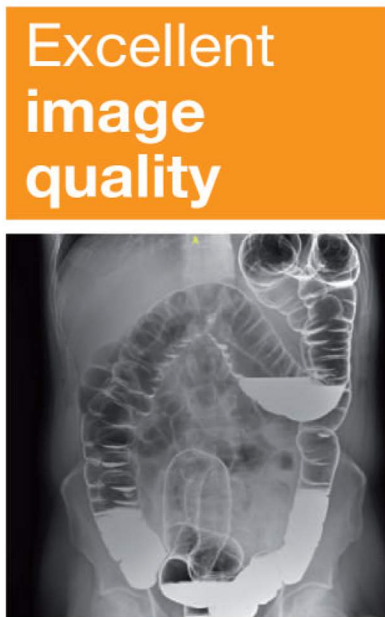
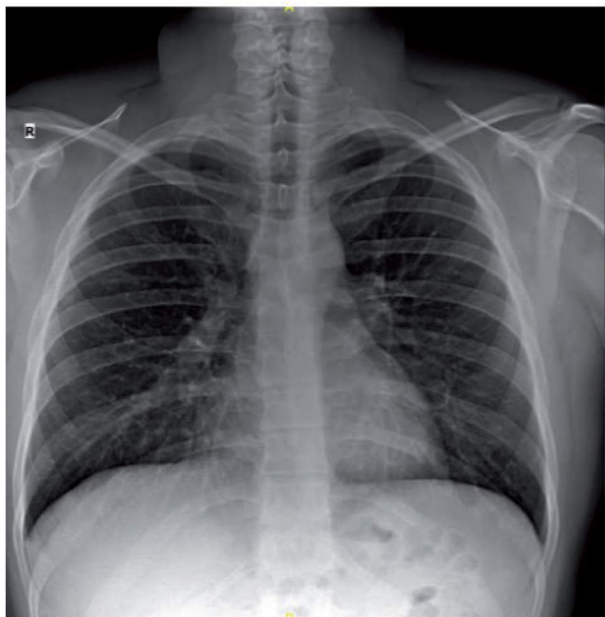
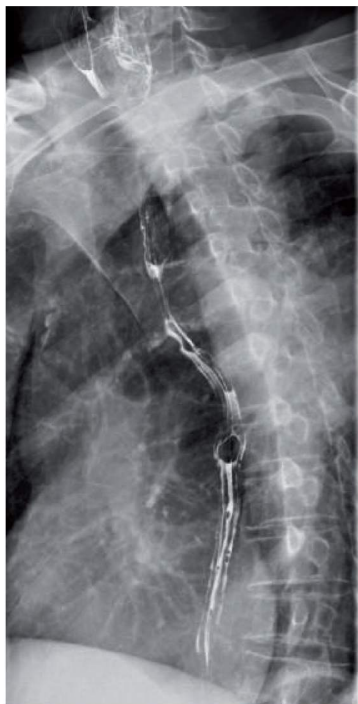

Excellent
image
quality

The Swiss Accuracy

On account of certain regional limitations of sales rights and service availability, we cannot guarantee that all products included in this brochure are available through the GMI sales organization worldwide. Availability and packaging may vary by country and is subject to change without prior notice.

The information in this document contains general technical descriptions of specifications and options as well as standard and optional features which do not always have to be present in individual cases.

GMI reserves the right to modify the design, packaging, specifications and options described herein without prior notice. Please contact your local GMI sales representative for the most current information.

Note: Any technical data contained in this document may vary within defined tolerances. Original images always lose a certain amount of detail when reproduced.

GMI®

General Medical Italia Ltd

ENGLAND

17 Carlisle Street, W1D 3BU London (UK)
Tel. +44(0) 207 283 7489 - www.gmitalia.co.uk

SWITZERLAND

Piazzetta L. Fontana 4 - 6850 - Mendrisio (CH)
Tel +41 971 25 47 - www.gmint.ch

ITALY

Via Enrico Fermi 26 - 24050 Grassobbio (BG)
Tel +39 035 65 948 11 - www.gmint.ch

